



**GREAT PLAINS INDUSTRIES, INC.**

"A Great Plains Ventures Subsidiary"

www.gpipumps.net

1-800-835-0113

# MR 5-30 or MR 5-30N Series Fuel Meter

## Owner's Manual

**STOP**

**DO NOT RETURN THIS PRODUCT TO THE STORE!**

Please contact GPI before returning any product. If you are missing parts or experience problems with your installation, our Customer Support Department will be happy to assist you.

GPI Customer Support  
800-835-0113 or  
316-686-7361



### TABLE OF CONTENTS

General Information..... 2

Installation ..... 2

Operation..... 3

Calibration ..... 4

Maintenance ..... 4

Troubleshooting..... 5

Specifications ..... 5

Illustrated Parts Drawing ..... 6

Illustrated Parts List ..... 6

Parts and Service ..... 7

### To the owner...

Congratulations on receiving your GPI MR 5-30 Meter. We are pleased to provide you with a meter designed to give you maximum reliability and efficiency.

Our business is the design manufacture, and marketing of liquid handling, agricultural, and recreational products. We succeed because we provide customers with innovative, reliable, safe, timely, and competitively-priced products. We pride ourselves in conducting our business with integrity and professionalism.

We are proud to provide you with a quality product and the support you need to obtain years of safe, dependable service.

President  
Great Plains Industries, Inc



Great Plains Industries, Inc. is a member of the Petroleum Equipment Institute.

## GENERAL INFORMATION

The purpose of this manual is to assist you in installing, operating and maintaining your mechanical fuel meter. Please take a few moments to read these instructions before installing and operating your fuel meter.



## SAFETY INSTRUCTIONS

The following safety alert symbols are used in this manual.



**DANGER** indicates a hazardous situation which, if not avoided, will result in death or serious injury.





**WARNING** indicates a hazardous situation which, if not avoided, could result in death or serious injury.



**CAUTION** indicates a hazardous situation which, if not avoided, may result in minor or moderate injury.

It is your responsibility to:

- know and follow applicable national, state and local safety codes pertaining to installing and operating electrical equipment for use with flammable liquids.
  - know and follow all safety precautions when handling petroleum fuels
  - ensure that all equipment operators have access to adequate instructions concerning safe operation and maintenance.
1. This meter is designed for use only with thin viscosity petroleum fuels such as gasoline (up to 15% alcohol blends such as E15), diesel fuel, and kerosene.

2. Do not use this equipment for dispensing any fluids other than those for which it was designed. To do so may damage the meter and will void the warranty.
3.  **DANGER** Observe precautions against fire or explosion when dispensing fuel. Do not operate the meter in the presence of any source of ignition including running or hot engines, lighted cigarettes, or gas or electric heaters.
4.  **WARNING** Any components such as hose, nozzle, or pump added to your meter must be statically grounded and approved for use with petroleum fuels.
5.  **WARNING** Avoid prolonged skin contact with petroleum fuels. Use protective goggles, gloves, and aprons in case of accidental splashing or spillage. Change saturated clothing and wash skin contact areas promptly with soap and water.

The MR 5-30 Mechanical Fuel Meter is designed for the field measurement of thin viscosity petroleum fuels only and intended for use with pump systems in the 5 to 30 GPM or 19 to 114 LPM flow range (not intended for gravity flow systems). Using mechanical gears, these meters translate flow data from a nutating disc into calibrated units which are indicated on the face of the meter. This meter is factory calibrated for diesel fuel. Field calibration feature is available for other fluids, see Calibration section.

## INSTALLATION

Before installing your meter, review the safety instructions given above. Examine your meter to make sure there are no visible signs of shipment damage. Plan your meter installation by reviewing the following procedures. Your system must be mounted on a vented tank. If the tank is unvented, your local dealer or distributor can supply a pressure cap.

If the meter is located in a rigid piping system where the fluid is trapped (for

example, by gravity, valves or nozzles) thermal expansion of the fluid can create pressure spikes that can damage a meter.

Install a thermal relief valve or otherwise allow for thermal expansion of the fluid. Prior to installation, determine the fitting angle desired and whether horizontal or vertical orientation is required.

### Rotate Fittings

To rotate inlet and/or outlet fittings, remove the two nuts and bolts that secure each fitting. Rotate the fitting to the desired orientation. Make sure the O-ring is fully seated. Tighten the nuts and bolts snugly.

### Change Orientation

1. Pull the knob to remove from unit. Remove screws that hold bezel in place and set aside.
2. Remove the two screws that hold the faceplate in place and remove faceplate. (Figure 1)

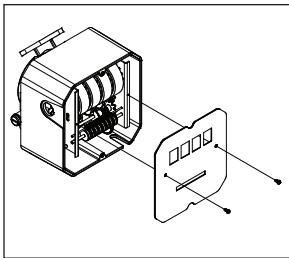

Figure 1

3. Remove two screws to release the counter assembly. (Figure 2)

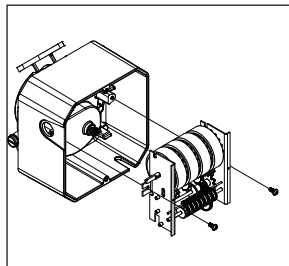

Figure 2

4. Remove the bevel gear from the center of the coverplate. Remove the eight pairs of nuts and bolts that hold the coverplate assembly in place.
5. Now you can rotate the coverplate to the desired orientation. Reassemble in reverse order, making sure the O-ring is fully seated. Torque eight nuts and bolts to 60 - 72 in-lb.

### Meter Installation

1. Remove protective plugs from the meter inlet and outlet ports.
2. Wrap threaded male connections with thread tape or use a pipe sealant compound compatible with petroleum fuels. We recommend thread sealant at the inlet fitting in horizontal orientation.
3. Install the meter on the pump using an appropriately sized nipple. The meter's flow path is marked on the housing exterior with an arrow pointing toward the outlet port.
4. Install other system components on the meter and tighten snugly.

## OPERATION

**ALWAYS FOLLOW SAFETY PRECAUTIONS WHEN OPERATING THIS EQUIPMENT. REVIEW THE SAFETY INSTRUCTIONS.** Before each use, visually check the meter to ensure it is securely connected to other system components and there is no leakage. Promptly wipe spilled fuel from the meter's exterior and other system components.

The large meter display represents the Batch Total for each fuel delivery. Before dispensing, reset the Batch Total to zero by turning the knob. (Figure 3)

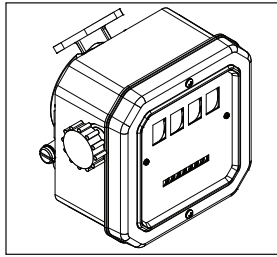

Figure 3

The small display represents the Cumulative Total of all fuel deliveries and cannot be reset.

## CALIBRATION

The meter is accurately calibrated at the factory for use with diesel fuel. Due to differences in viscosity and flowrates, the meter may require recalibration to measure other fuels or to adjust for inaccuracies.

1. Purge air from the meter and fuel system by dispensing fuel into a container until a full flow occurs. Close the nozzle.
2. Reset the meter counter to zero by turning the reset knob. (Figure 3)
3. Pump into a graduated calibration container to a specified quantity. For the greatest accuracy, be sure the container is placed on a level surface and a consistent flow rate is used. When topping off the calibration container, use a quick-open and quick-close method until the mark is reached.
4. Compare the meter display to the quantity in the container. If the meter display does not register the quantity on the container, adjust the meter by performing the following:
  - a. Gain access to the recessed calibration screw by turning the calibration screw cover and seal counterclockwise. Remove the cover and nylon washer. (Figure 4)

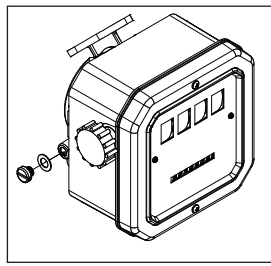

Figure 4

- b. If the meter registered less than the quantity in the container, turn the calibration screw clockwise. If the meter registered more than the amount in the container, turn the calibration screw counterclockwise.
5. Empty the calibration container and repeat steps 2 to 4 until the meter registers the quantity in the container.
  6. Install the nylon washer and calibration screw cover.

## MAINTENANCE

The meter's strainer should be cleaned at regular intervals, especially when low flow is detected.

### Clean or Replace Strainer

1. Remove the nuts and bolts at the inlet fitting. Remove the fitting, O-ring, and strainer.
2. Using a fine brush, clean the strainer. Replace the strainer as necessary.
3. Wipe clean the inlet, housing, and O-ring groove. Coat the O-ring with oil or light grease. Make sure the O-ring is fully seated. Replace the strainer.
4. Position the inlet fitting in the desired orientation and tighten the nuts and bolts to 60 - 72 in-lb.

## TROUBLESHOOTING

Symptom	Probable Cause	Corrective Action
A. Meter counter does not operate. (Normal fuel delivery)	1. Broken counter assembly.	Replace counter.
	2. Foreign material in counter assembly or nutator assembly.	Remove and clean counter assembly or nutator assembly.
	3. Broken nutator disc pin or defective nutator assembly.	Install new nutator assembly.
	4. Missing or worn bevel gear.	Replace bevel gear.
B. Meter counter does not operate.  (Little or no fuel flow)	1. Clogged strainer in meter.	Clean or replace strainer.
	2. Other system components malfunctioning.	Check all system components tank to nozzle for clogs and/or malfunctions. Repair as necessary.
	3. Foreign material in nutator assembly.	Remove and clean nutator assembly.
C. Fuel leakage.	1. Leakage at counter drive shaft.	Replace coverplate assembly.
	2. Leakage between coverplate and housing.	Remove coverplate and inspect for damaged, missing or incorrectly seated seal. Replace as required.
	3. Leakage at fittings.	Remove fittings and inspect for damaged, missing or incorrectly seated seals. Replace as required.
	4. Leakage at threads.	Remove meter and reseal all threaded connections with thread tape or pipe thread sealing compound approved for use with flammable liquids.

## SPECIFICATIONS

	<b>Gallon Models</b>	<b>Litre Models</b>
Unit of Measure	U.S. Gallon	Litre
Flow Range	5 to 30 GPM	19 to 114 LPM
Typical Accuracy	± 2%	± 2%
Type	Nutating Disc	Nutating Disc
Housing Material	Aluminum	Aluminum
Maximum Working Pressure	50 PSIG	3.4 bar
Inlet/Outlet Fitting Size	3/4"* , 1" or 1-1/2"	3/4"* , 1" or 1-1/2"
Threads	NPT	NPT or BSPP*
Maximum Batch Total	999.9	9999
Maximum Cumulative Total	999,999.9	9,999,999
Approximate Ship Weight	8.1 lbs.	3.7 kg
Maximum Dimensions:	Width: 8.0 inches	20.3 cm
	Height: 7.0 inches	17.8 cm
	Depth: 6.0 inches	15.2 cm

\* Not available on ENP model.

Note: Accuracy is factory calibrated using diesel fuel. Field Calibration is available on all models.

## ILLUSTRATED PARTS DRAWING

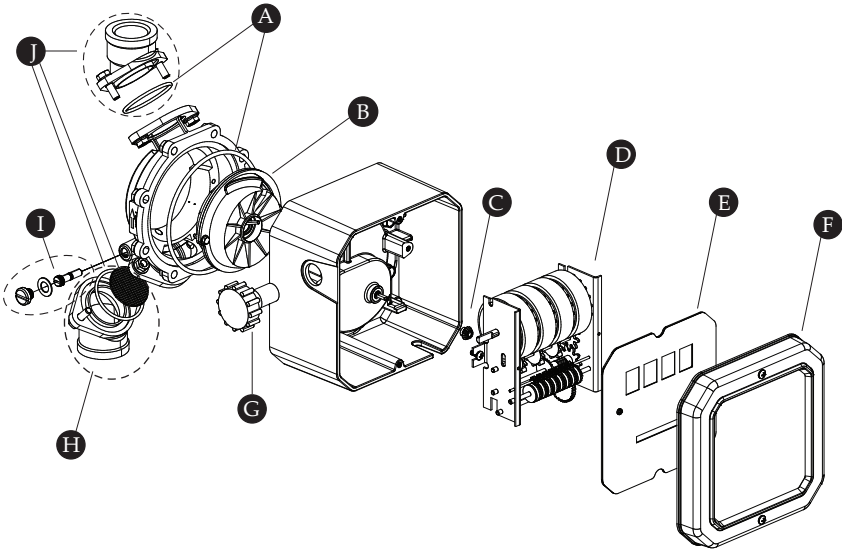

### Kits and Accessories

	Part No.	Description
<b>A</b>	126530-09	Seal Kit - includes one housing O-ring and two fitting O-rings
	126530-59	Seal Kit - ENP model
<b>B</b>	126530-08	Nutator Assembly Kit - includes hardware
	126530-58	Nutator Assembly Kit - ENP model
<b>C</b>	126530-06	Bevel Gear Kit
<b>D</b>	126530-04	Gallon Counter Assembly Kit - includes counter assembly and hardware
	126530-05	Litre Counter Assembly Kit - includes counter assembly and hardware
<b>E</b>	126530-02	Gallon Faceplate Kit - includes faceplate, decal and hardware
	126530-52	Gallon Faceplate Kit - ENP model
	126530-03	Litre Faceplate Kit - includes faceplate, decal and hardware
<b>F</b>	126530-01	Bezel Kit -includes hardware
<b>G</b>	126530-07	Knob Assembly Kit
<b>H</b>	126530-12	Fitting Kit for 3/4-inch NPT (2 Fittings, 2 Fitting O-Rings, 1 strainer and hardware)
	126530-13	Fitting Kit for 3/4-inch BSPP (2 Fittings, 2 Fitting O-Rings, 1 strainer and hardware)
	126530-14	Fitting Kit for 1-inch NPT, (2 Fittings, 2 Fitting O-Rings, 1 strainer and hardware)
	126530-64	Fitting Kit for 1-inch NPT, ENP model

ENP model includes stainless hardware for wetted components. The housing is ENP and the seals are Fluorocarbon instead of Nitrile.

## Kits and Accessories, continued

Kit No.	Part No.	Description
	126530-15	Fitting Kit for 1-inch BSPP (2 Fittings, 2 Fitting O-Rings, 1 strainer and hardware)
	126530-16	Fitting Kit for 1-1/2 inch NPT (2 Fittings, 2 Fitting O-Rings, 1 strainer and hardware)
	126530-66	Fitting Kit for 1-1/2 inch NPT, ENP model
	126530-17	Fitting Kit for 1-1/2 inch BSPP (2 Fittings, 2 Fitting O-Rings, 1 strainer and hardware)
<b>I</b>	126530-11	Calibration Screw Kit - includes screw, washer O-ring & cover
<b>J</b>	126530-10	Hardware Kit - includes O-rings, strainer, nuts & screws
	126530-60	Hardware Kit - ENP model

### PARTS AND SERVICE

For warranty consideration, parts, or other service information, contact your local distributor. If you need further assistance, please contact GPI Customer Service Department in Wichita, Kansas during normal business hours at 1-800-835-0113.

To obtain prompt, efficient service, always be prepared with 1.) the model number of your meter, 2.) the manufacturing date located on the back of the meter, and 3.) specific information, as necessary, obtained from the Illustrated Parts List. For warranty work always be prepared with proof of purchase date.

Please contact GPI before returning any parts. It may be possible to diagnose the trouble and identify needed parts without returning parts. GPI can also inform you of any special handling requirements you will need to follow covering the transportation and handling of fuel transfer equipment. Before packing for shipment, make sure the meter is thoroughly drained and free of fuel and vapors.

### CAUTION

Do not return meters or parts without specific authority from the GPI Customer Service Department. Due to strict regulations governing shipment of flammable liquids, meters may be refused and returned to the sender if sent without authorization.

## Limited Warranty Policy

Great Plains Industries, Inc. 5252 E. 36<sup>th</sup> Street North, Wichita, KS USA 67220-3205, hereby provides a limited warranty against defects in material and workmanship on all products manufactured by Great Plains Industries, Inc. This product includes a 2 year warranty from date of purchase as evidenced by the original sales receipt. A 30 month warranty from product date of manufacture will apply in cases where the original sales receipt is not available. Reference product labeling for the warranty expiration date based on 30 months from date of manufacture. Manufacturer's sole obligation under the foregoing warranties will be limited to either, at Manufacturer's option, replacing or repairing defective Goods (subject to limitations hereinafter provided) or refunding the purchase price for such Goods theretofore paid by the Buyer, and Buyer's exclusive remedy for breach of any such warranties will be enforcement of such obligations of Manufacturer. The warranty shall extend to the purchaser of this product and to any person to whom such product is transferred during the warranty period.

This warranty shall not apply if:

- A. the product has been altered or modified outside the warrantor's duly appointed representative;
- B. the product has been subjected to neglect, misuse, abuse or damage or has been installed or operated other than in accordance with the manufacturer's operating instructions.

To make a claim against this warranty, contact the GPI Customer Service Department at 316-686-7361 or 800-835-0113. Or by mail at:

Great Plains Industries, Inc.  
5252 E. 36<sup>th</sup> St. North  
Wichita, KS, USA 67220-3205

GPI will step you through a product troubleshooting process to determine appropriate corrective actions.

**GREAT PLAINS INDUSTRIES, INC., EXCLUDES LIABILITY UNDER THIS WARRANTY FOR DIRECT, INDIRECT, INCIDENTAL AND CONSEQUENTIAL DAMAGES INCURRED IN THE USE OR LOSS OF USE OF THE PRODUCT WARRANTED HEREUNDER.**

The company herewith expressly disclaims any warranty of merchantability or fitness for any particular purpose other than for which it was designed.

This warranty gives you specific rights and you may also have other rights which vary from U.S. state to U.S. state.

Note: In compliance with MAGNUSON MOSS CONSUMER WARRANTY ACT – Part 702 (governs the resale availability of the warranty terms).



UL Listing only applies to models with NPT threads



5252 East 36th Street North  
Wichita, KS USA 67220-3205  
TEL: 316-686-7361  
FAX: 316-686-6746

***GREAT PLAINS INDUSTRIES, INC.***

*"A Great Plains Ventures Subsidiary"*

www.gpipumps.net  
**1-800-835-0113**

GPI is a registered trademark of Great Plains Industries,  
©2011 GREAT PLAINS INDUSTRIES, INC., Wichita, KS.  
Printed in U.S.A.